

Desenho Técnico III

Capítulo 12 Desenho Técnico de Juntas Soldadas

OBJECTIVOS

- Enumerar os tipos de soldadura mais importantes;
- Diferenciar soldadura, brasagem, soldobrasagem e colagem
- Representar com a simbologia própria as juntas soldadas em construção mecânica;
- Identificar os diferentes tipos de soldadura através da leitura dos desenhos;
- Proceder à cotagem de cordões de soldadura

DESENHO TÉCNICO DE JUNTAS SOLDADAS

- Exemplos típicos de aplicação de soldadura para a junção de peças

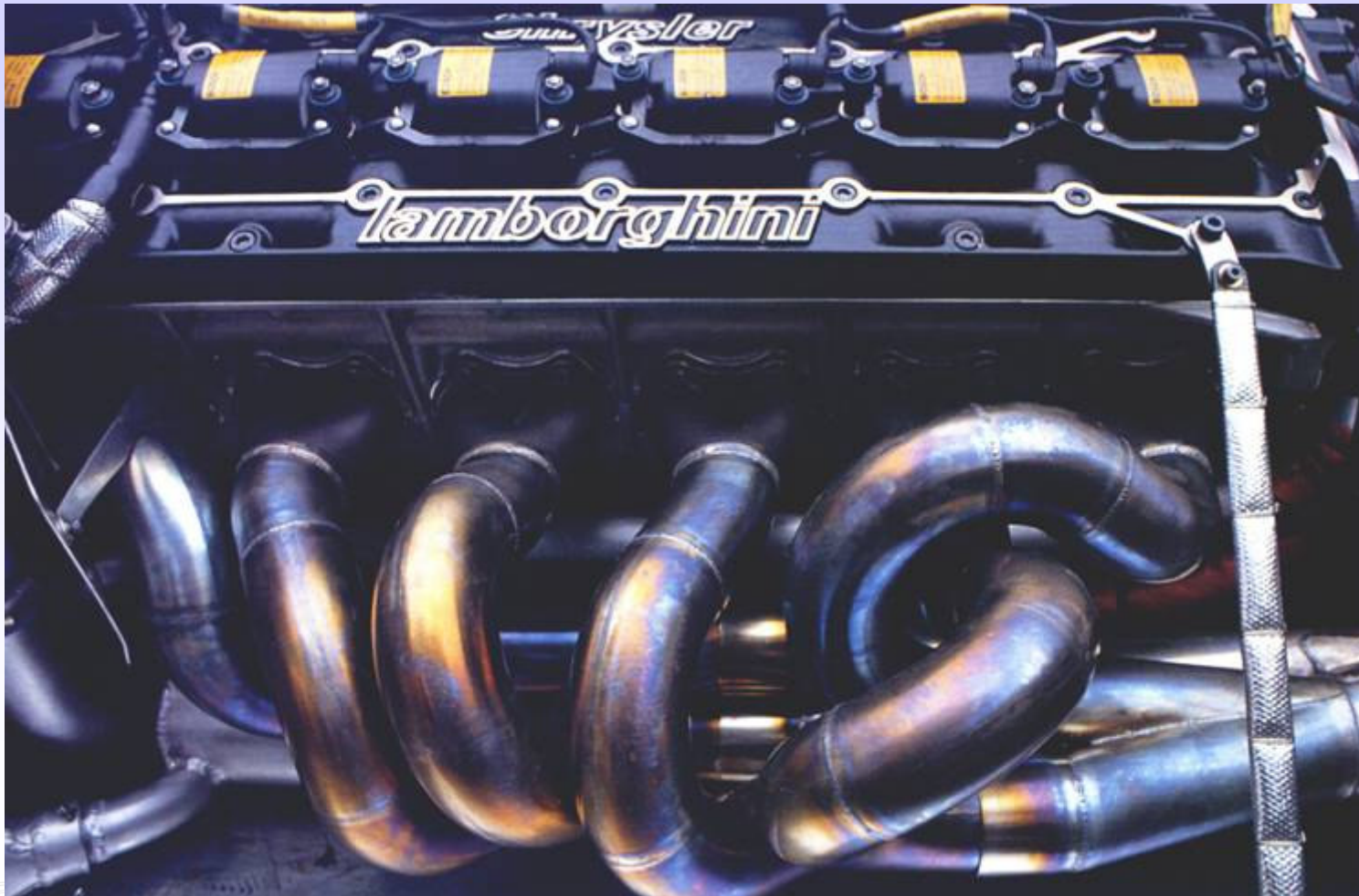

DESENHO TÉCNICO DE JUNTAS SOLDADAS

- Soldadura por chama

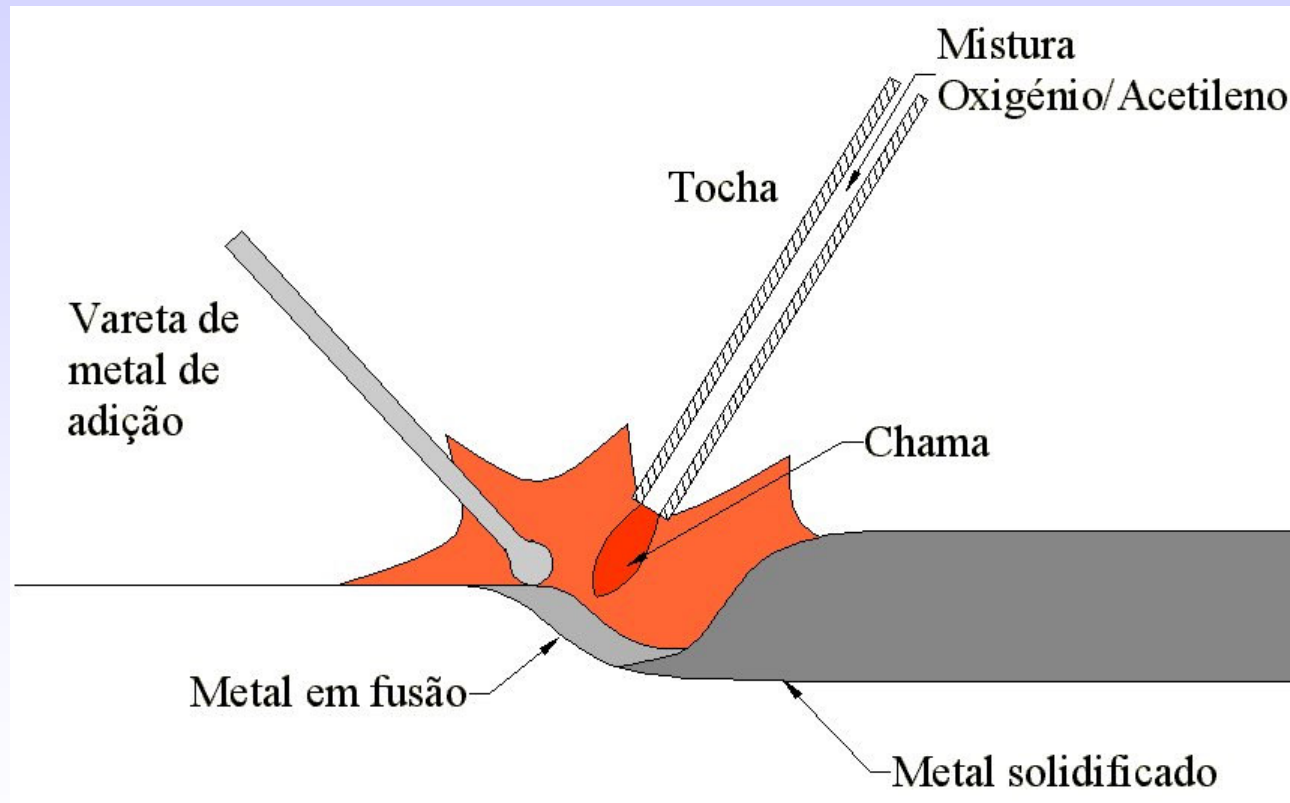

DESENHO TÉCNICO DE JUNTAS SOLDADAS

- Soldadura com eléctrodo revestido (arco eléctrico)

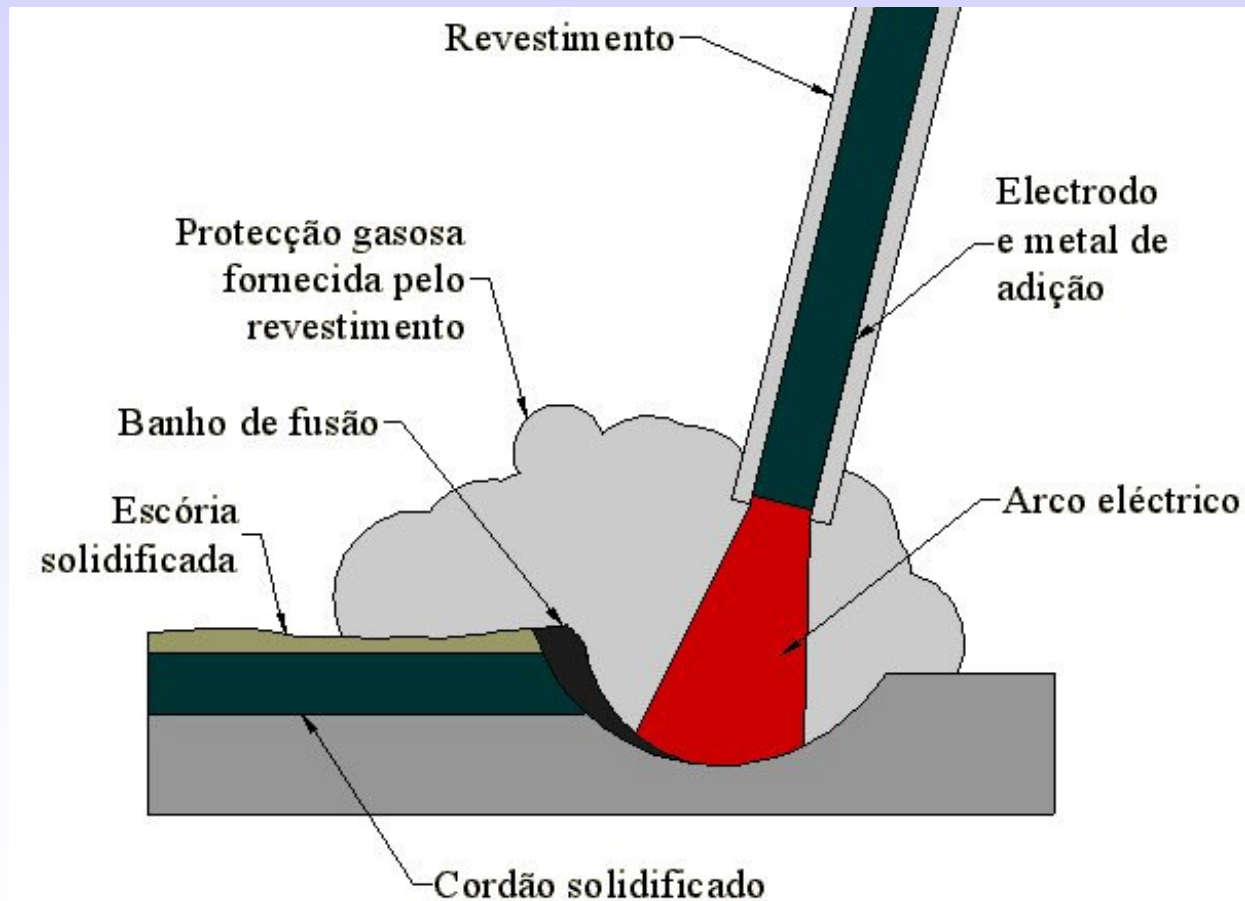

DESENHO TÉCNICO DE JUNTAS SOLDADAS

- Soldadura por arco (eléctrico) submerso

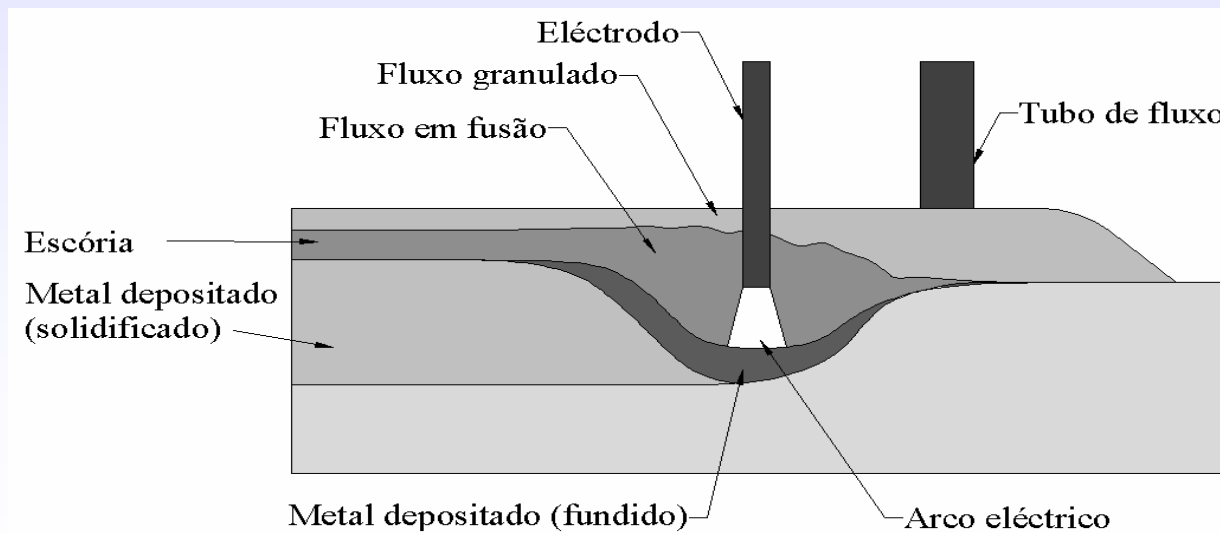
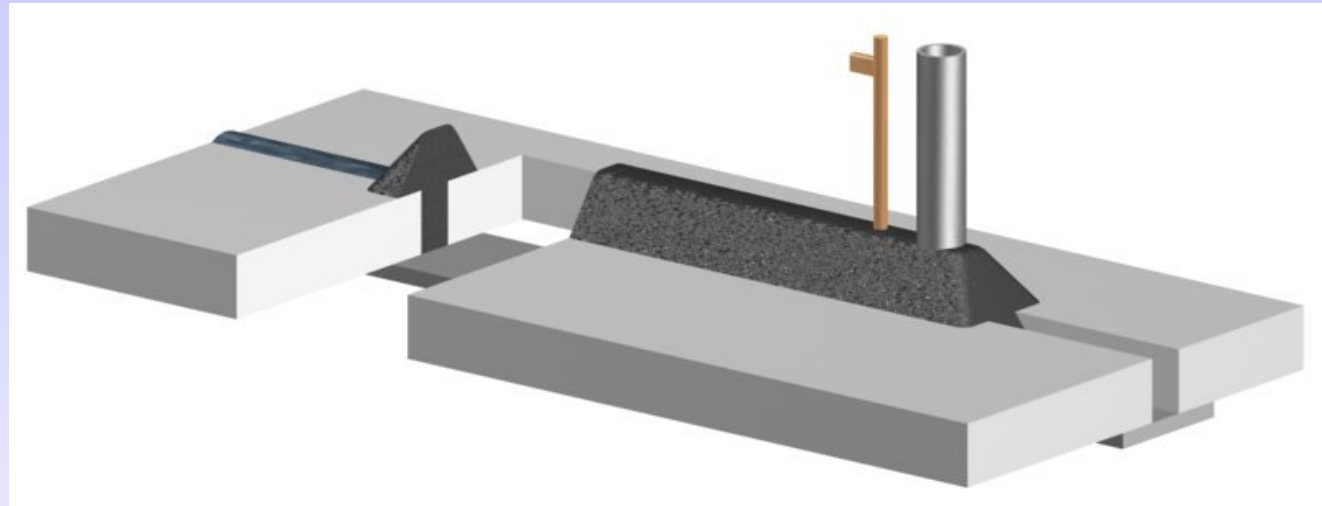

DESENHO TÉCNICO DE JUNTAS SOLDADAS

- Soldadura por resistência

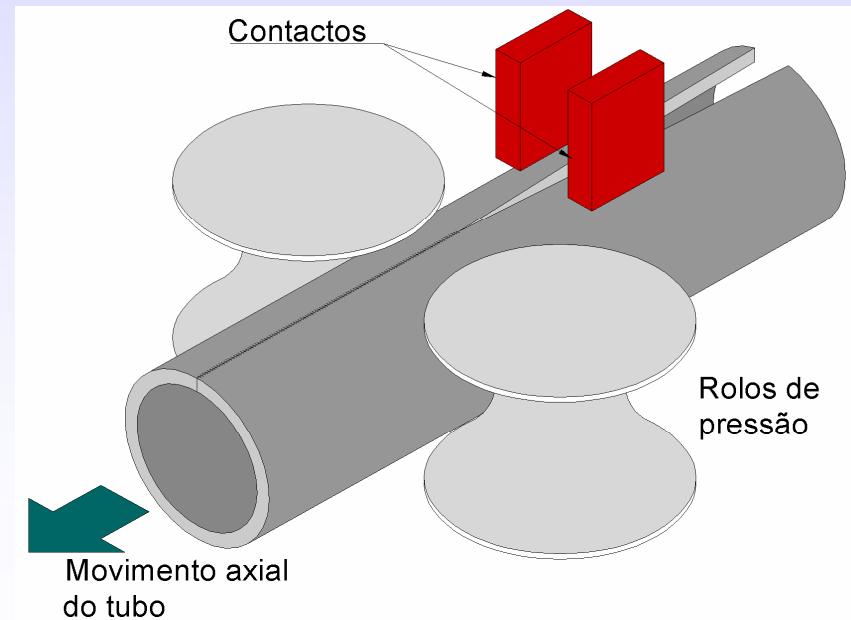
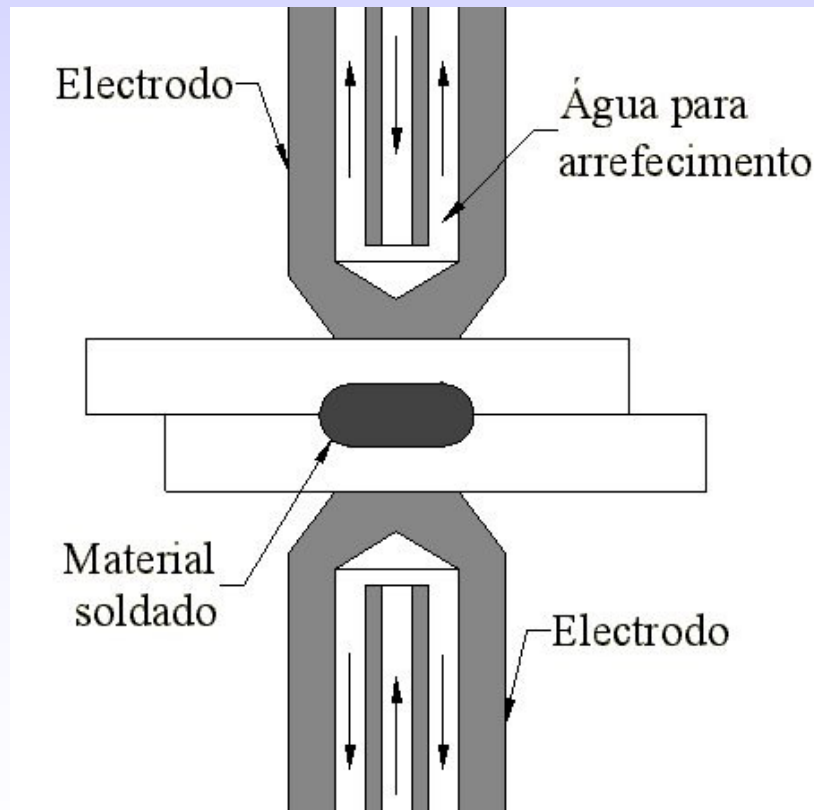

DESENHO TÉCNICO DE JUNTAS SOLDADAS

- Soldadura por fricção

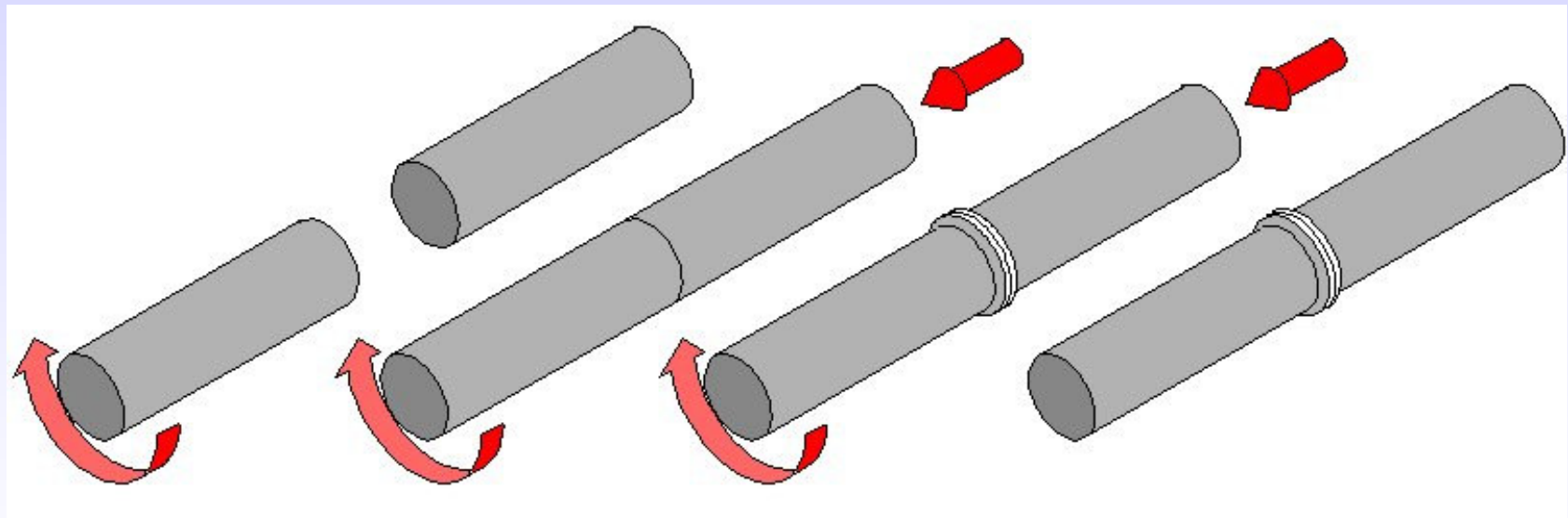

DESENHO TÉCNICO DE JUNTAS SOLDADAS

- Soldadura por electroescória

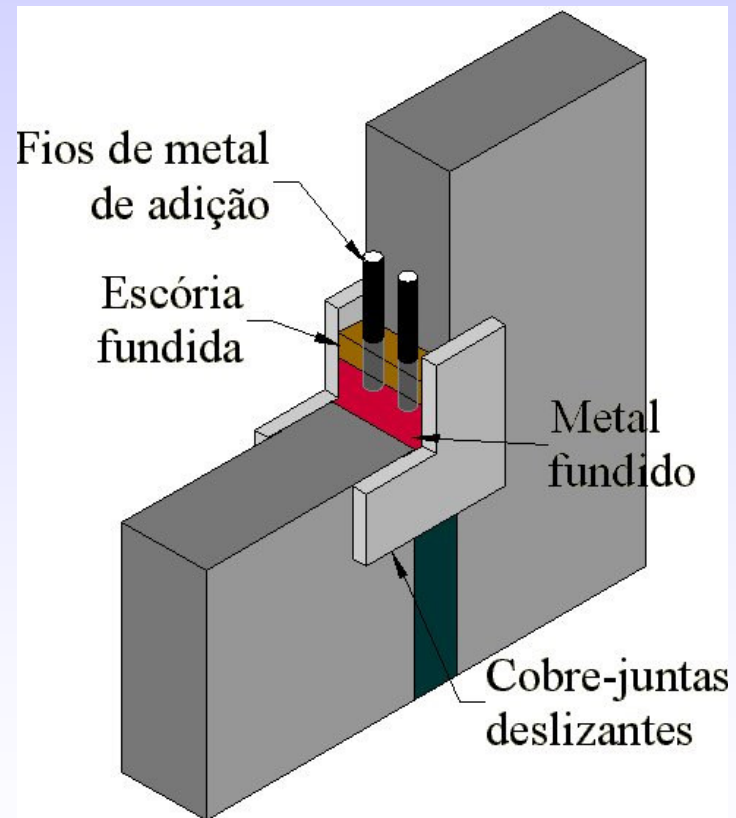





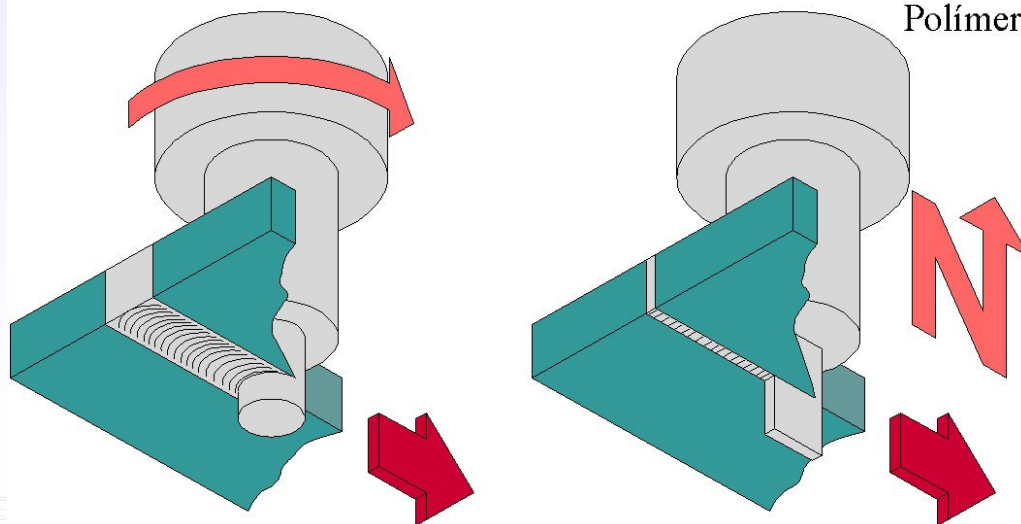
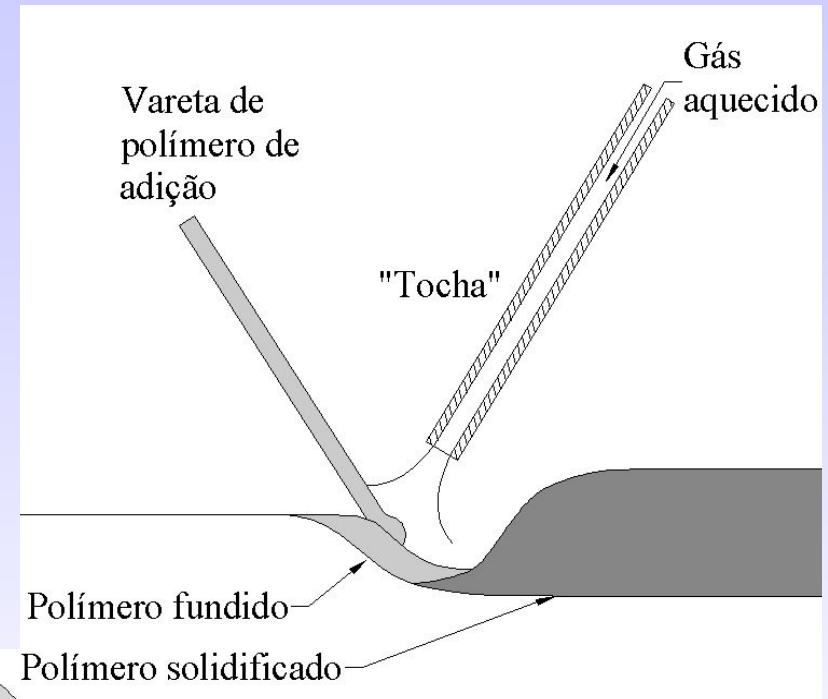





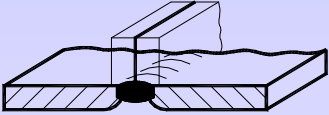

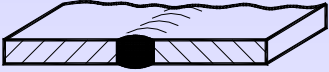
DESENHO TÉCNICO DE JUNTAS SOLDADAS

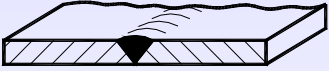
- Soldadura de polímeros















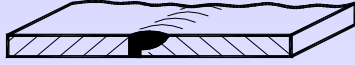

Símbolos elementares de soldadura

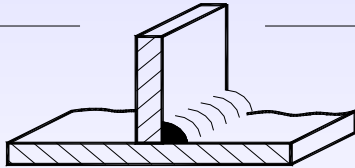
DESENHO TÉCNICO DE JUNTAS SOLDADAS

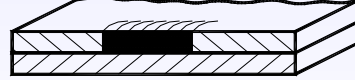
	Designação	Ilustração	Símbolo
1	Junta de bordos rebordados completamente fundidos		
2	Junta de bordos direitos		
3	Junta em V simples		
4	Junta em meio V simples		
5	Junta em Y simples		
6	Junta em meio Y simples		

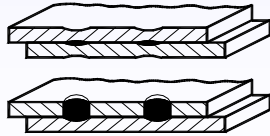











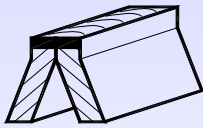

DESENHO TÉCNICO DE JUNTAS SOLDADAS

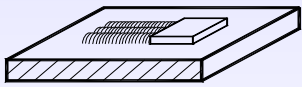
Símbolos elementares de soldadura (cont.)

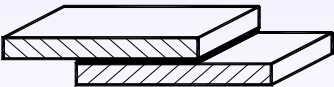
	Designação	Ilustração	Símbolo
7	Junta em tulipa (ou em U)		
8	Junta em meio U (ou em J)		
9	Cordão de confirmação na raiz da junta		
10	Junta em ângulo		
11	Soldadura em entalhe (ou perna de soldadura)		
12	Soldadura por pontos		
13	Soldadura em linha contínua		





DESENHO TÉCNICO DE JUNTAS SOLDADAS

Símbolos elementares de soldadura (cont.)

	Designação	Ilustração	Símbolo
14	Junta em V simples de bordos inclinados		
15	Junta em meio V simples de bordos inclinados		
16	Soldadura de bordo		
17	Enchimento		
18	Junta de superfície		
19	Junta inclinada		
20	Junta dobrada		

DESENHO TÉCNICO DE JUNTAS SOLDADAS

- Combinação de símbolos elementares

Designação	Ilustração	Símbolo
Junta em V dupla		X
Junta em meio V dupla		K
Junta em Y dupla		Y
Junta em meio Y dupla		K
Junta em U dupla		U

- Símbolos suplementares

Designação	Símbolo
Plana	—
Convexa	⌒
Côncava	⌒
De bordos arredondados tangentes	⌒
Cobre-junta permanente	⌈ M ⌋
Cobre-junta amovível	⌈ M R ⌋

DESENHO TÉCNICO DE JUNTAS SOLDADAS

Utilização conjunta
de símbolos elementares
e símbolos suplementares

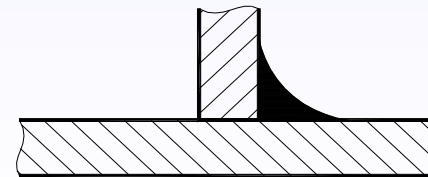
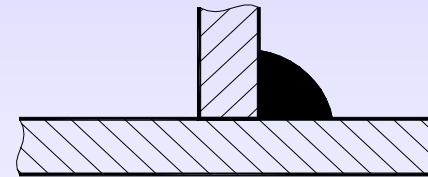
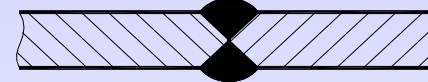
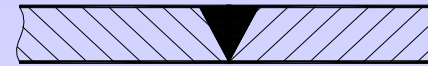

DESENHO TÉCNICO DE JUNTAS SOLDADAS

Método de referênciação de juntas soldadas

1 = flecha

2a = linha de referência (contínua)

2b = linha de identificação (interrompida)

3 = símbolo de soldadura

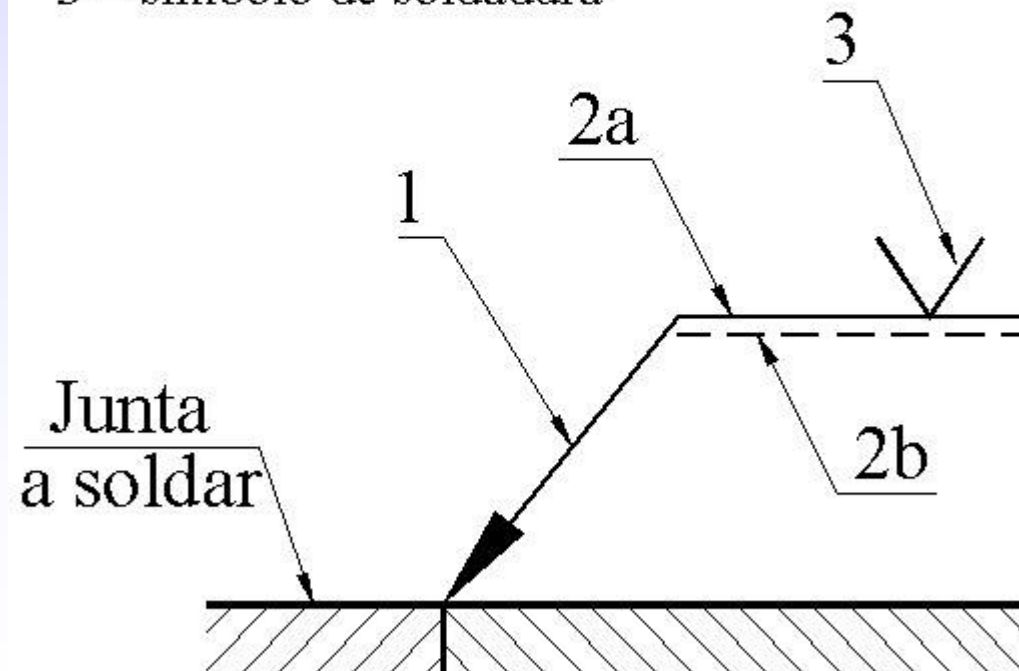

DESENHO TÉCNICO DE JUNTAS SOLDADAS

Posicionamento da flecha em relação à junta

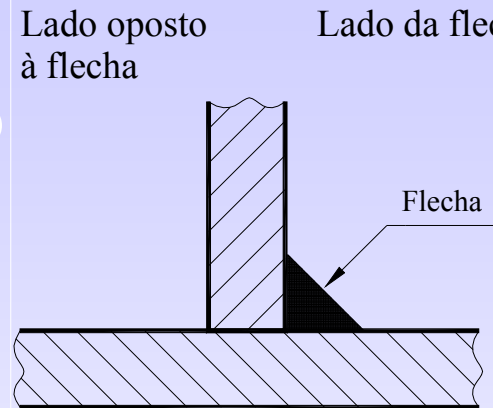

a) Soldadura do lado da flecha

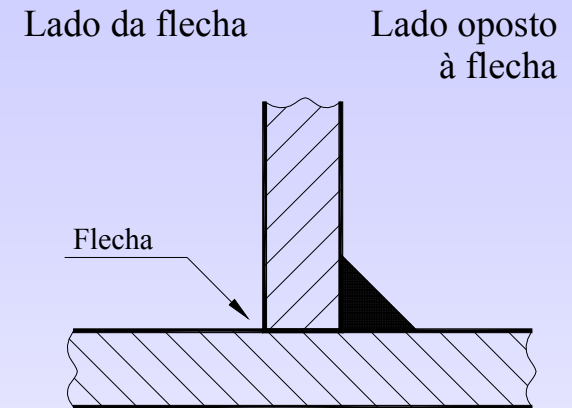

b) Soldadura do lado oposto à flecha

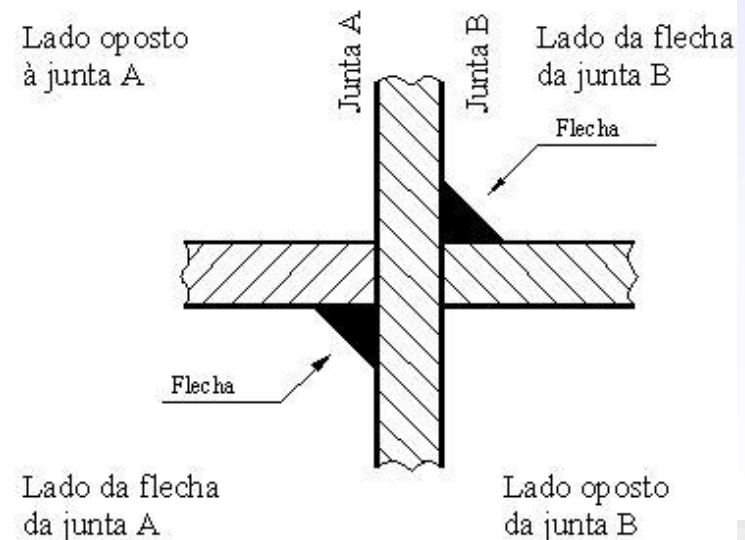
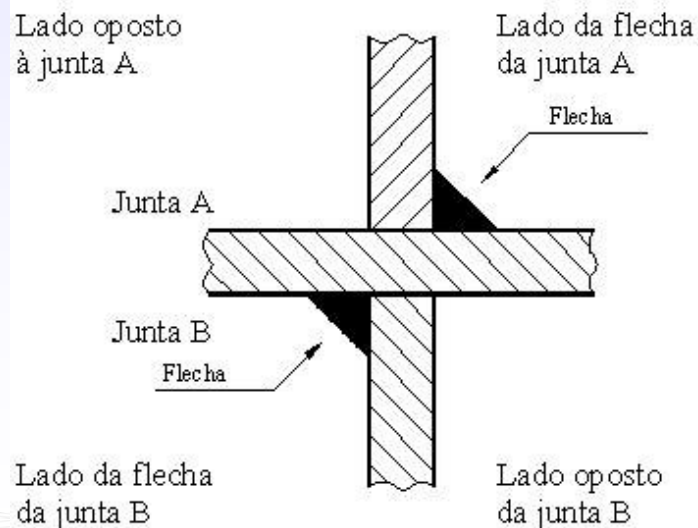

DESENHO TÉCNICO DE JUNTAS SOLDADAS

A flecha pode ser posicionada em qualquer destas posições, desde que o símbolo de soldadura seja colocado de acordo com a posição da flecha

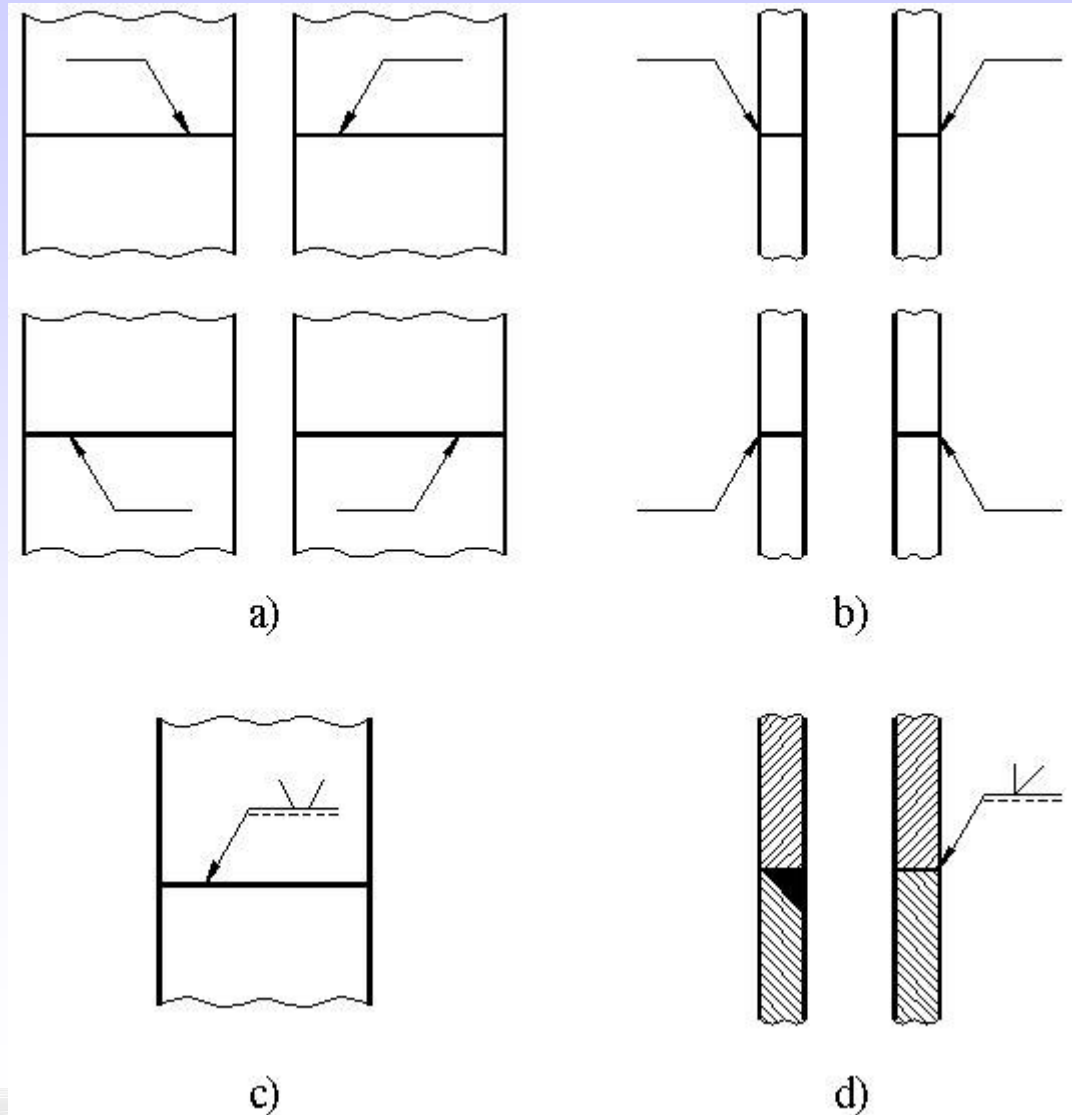

DESENHO TÉCNICO DE JUNTAS SOLDADAS

O símbolo de soldadura deve ficar sobre a linha contínua se a junta soldada estiver do lado da flecha, ou sobre a linha interrompida se a junta estiver no lado oposto à flecha

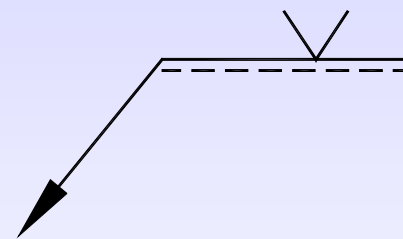
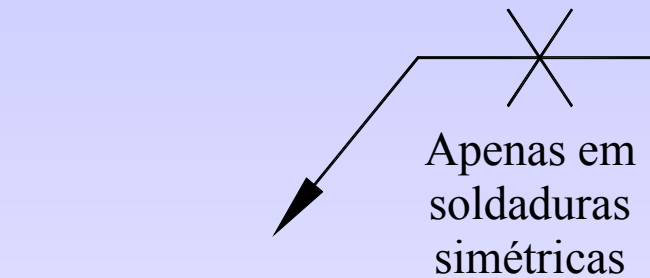

a) Soldadura a efectuar do lado da flecha

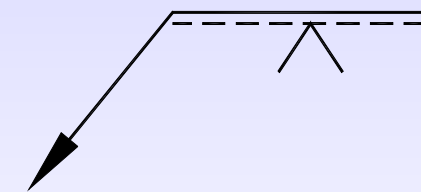

b) Soldadura a efectuar do lado oposto da flecha

DESENHO TÉCNICO DE JUNTAS SOLDADAS



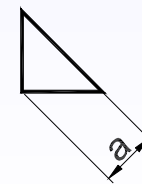
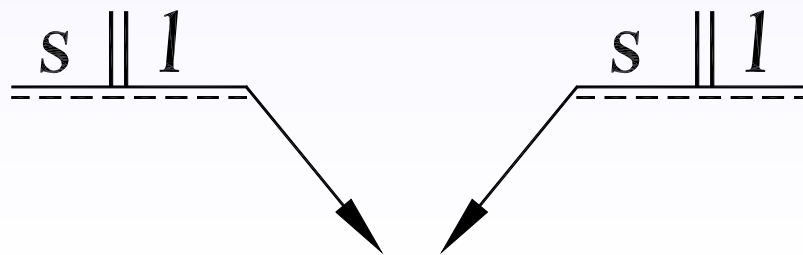
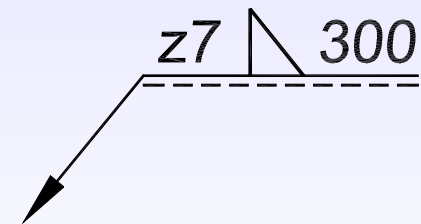
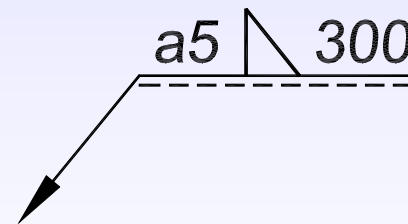
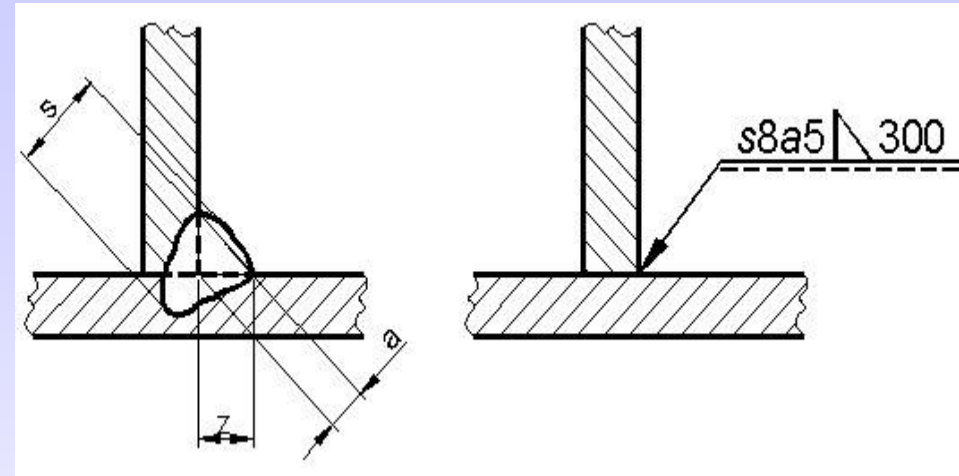

Cotagem de cordões de soldadura

A dimensão s da secção transversal do cordão deve ser inscrita à esquerda do símbolo de soldadura. Esta dimensão pode ser a da base do cordão, z , ou a da garganta do cordão, a . A dimensão longitudinal l do cordão deve ser inscrita à direita do símbolo de soldadura.

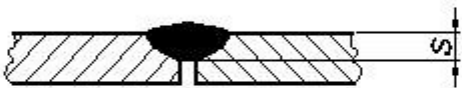

DESENHO TÉCNICO DE JUNTAS SOLDADAS

Exemplos de aplicação de símbolos e dimensões

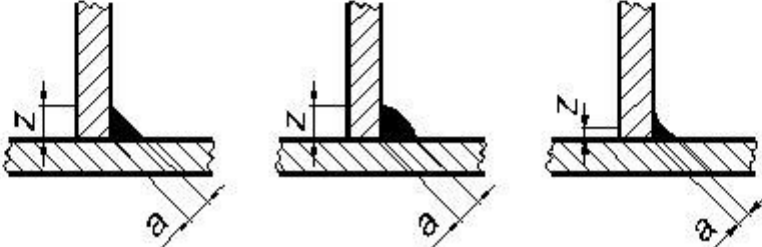
Designação	Ilustração	Inscrição
1 Junta de bordos direitos		∇
		$s \parallel$
		$s \Upsilon$
2 Junta de bordos rebordados		$s \parallel$
3 Juntas em ângulo contínuas		$a \triangle$ $z \triangle$

DESENHO TÉCNICO DE JUNTAS SOLDADAS

Designação	Ilustração	Inscrição
4 Junta em ângulo descontínua		$a \begin{array}{l} \triangle \\ n \times l(e) \end{array}$ $z \begin{array}{l} \triangle \\ n \times l(e) \end{array}$
5 Junta em ângulo intermitente desfasada		$\frac{a}{a} \begin{array}{l} \triangle \\ n \times l \end{array} \begin{array}{l} (e) \\ (e) \end{array}$ $\frac{z}{z} \begin{array}{l} \triangle \\ n \times l \end{array} \begin{array}{l} (e) \\ (e) \end{array}$
6 Soldadura em entalhe descontínua		$c \begin{array}{l} \square \\ n \times l(e) \end{array}$
7 Soldadura em linha descontínua		$c \begin{array}{l} \ominus \\ n \times l(e) \end{array}$
8 Soldadura por pontos		$d \begin{array}{l} \bigcirc \\ n(e) \end{array}$

DESENHO TÉCNICO DE JUNTAS SOLDADAS

Símbolos complementares

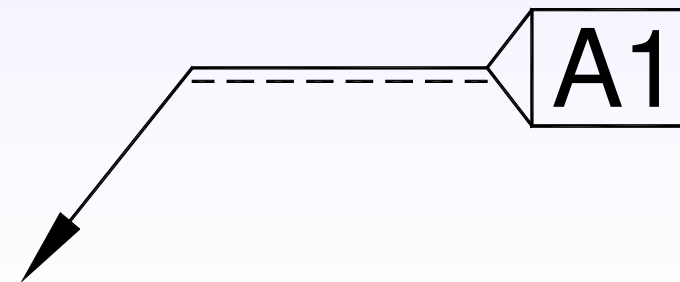
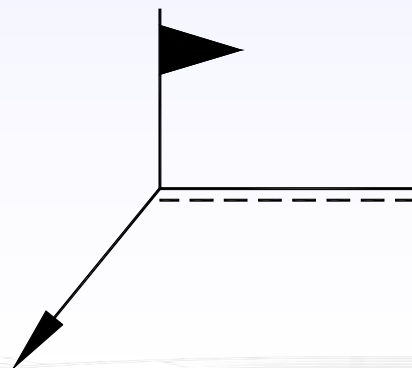
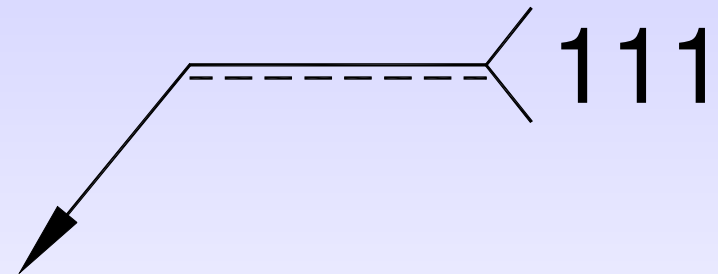
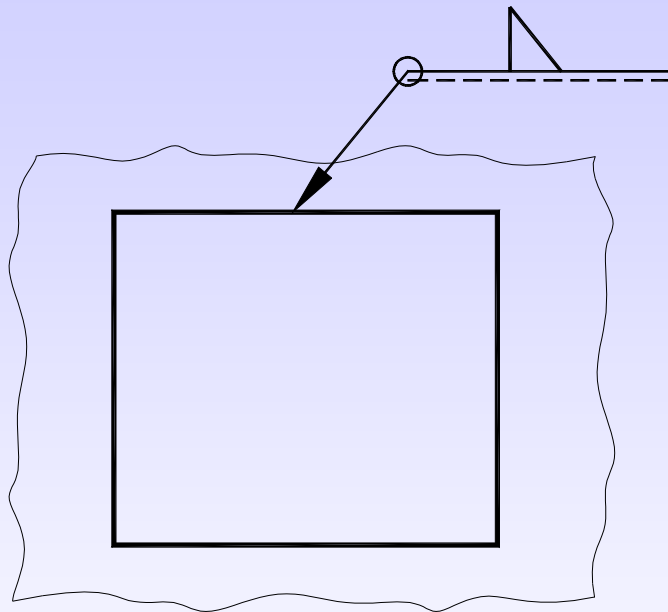

DESENHO TÉCNICO DE JUNTAS SOLDADAS

Colocação automática de simbologia em CAD

